

外視 / External view

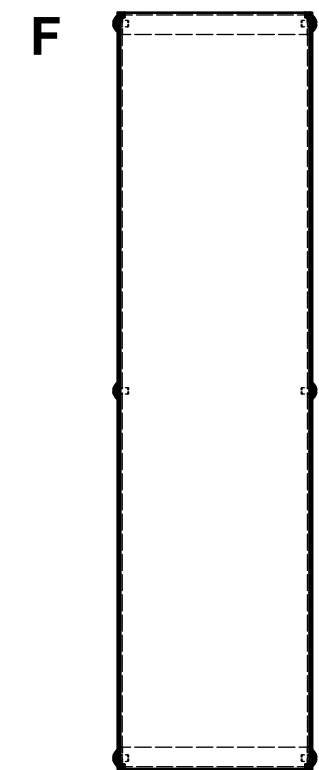

構成内容 / Components				
No.	名称 / Part name	数量 / Pcs	材質 / Material	色・表面処理 / Color・Finish
1	カバー Cover	1	ステンレス SUS304 t1.0 Stainless steel SUS304 t1.0	BA Polished-finish
2	シャーシ Base	1	ステンレス SUS304 t1.0 Stainless steel SUS304 t1.0	BA Polished-finish
3	取付ビス(トラスM3 x 5) Screw(Truss head M3 - 5)	6	ステンレス Stainless steel	無処理 Unfinished

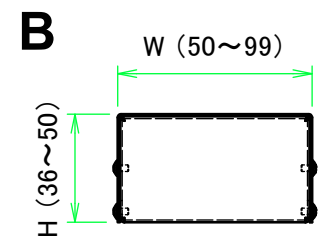
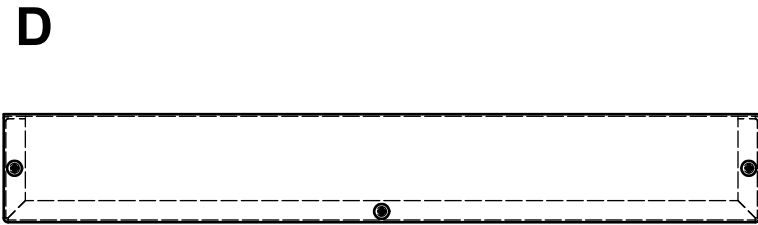
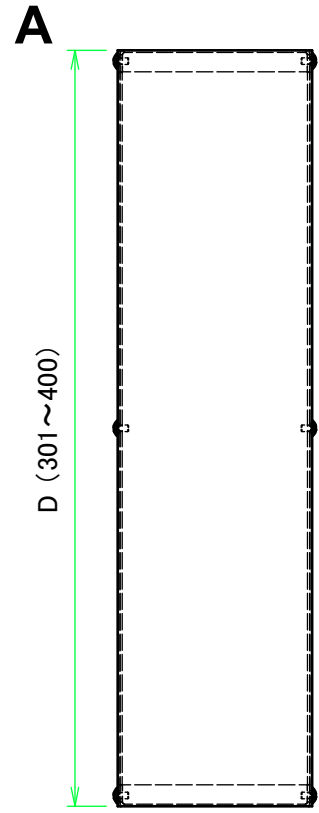
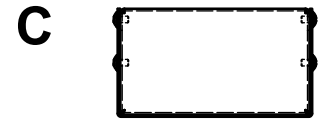
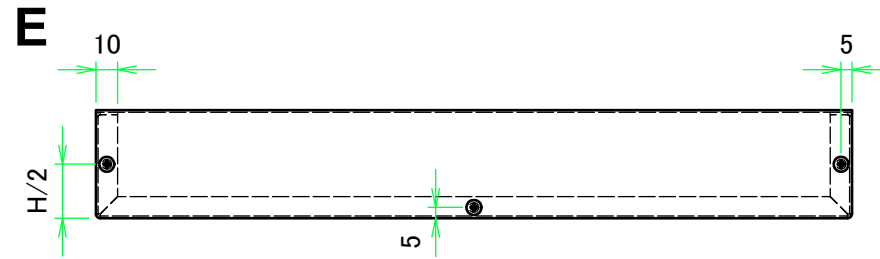
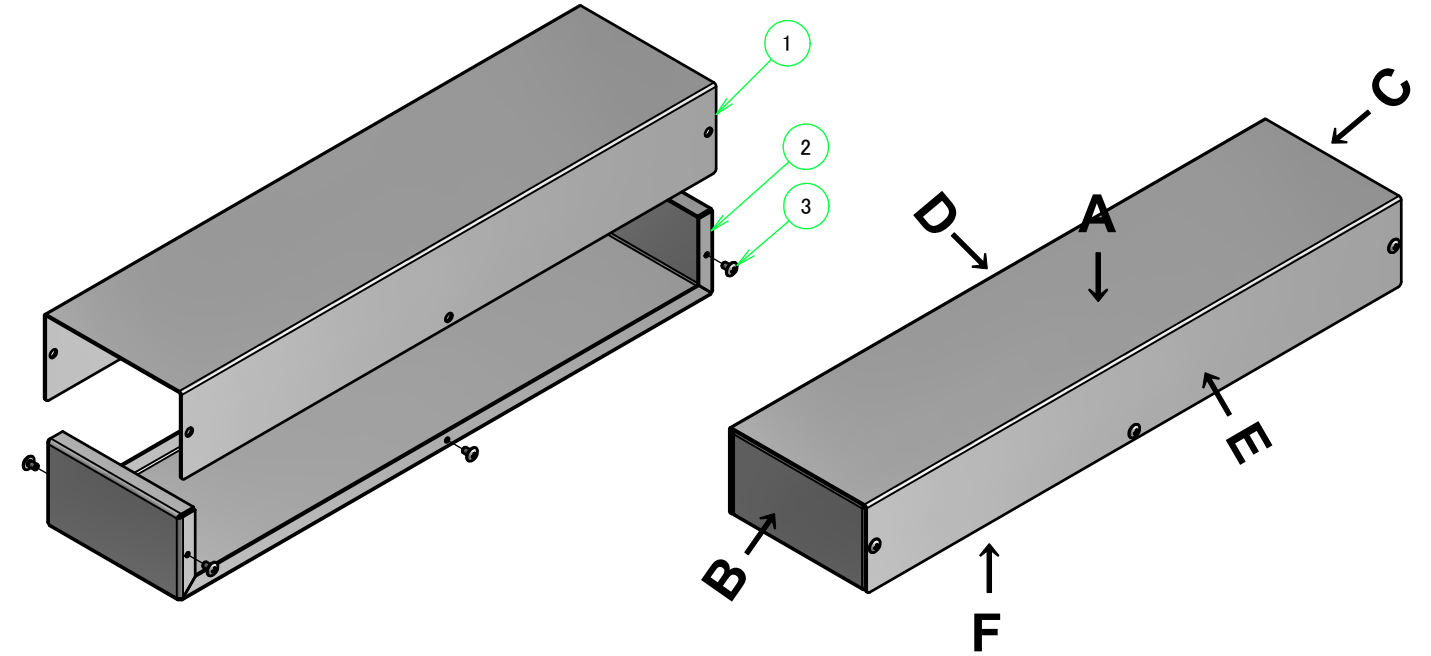

ケース型番 / Product Number

MBS - - B 10

W H D

シャーシタイプ・板厚(補強あり・t1.0)
Base type・thickness(reinforced・t1.0)

W・H・D 寸法制限範囲 / Dimension limit range		
W	H	D
50~99	36~50	301~400

* ケース寸法範囲内でも対応できない場合があります。詳細はカタログ内価格表でご確認ください。
* Size combinations available will vary based on each base type. For more information, refer to our catalog, or inquire.

株式会社タカチ電機工業 TAKACHI ELECTRONICS ENCLOSURE CO., LTD.			品名/Title ステンレスフリーサイズケース CUSTOM DIMENSIONS CASE	尺度/Scale
承認/Approved	検図/Checked	製図/Created	型番/Product number MBS□-□-□ B10 (D ≥ 301)	
中根	大江	横田	作成日/Date 2019/06/24	1 / 3

カバー / Cover

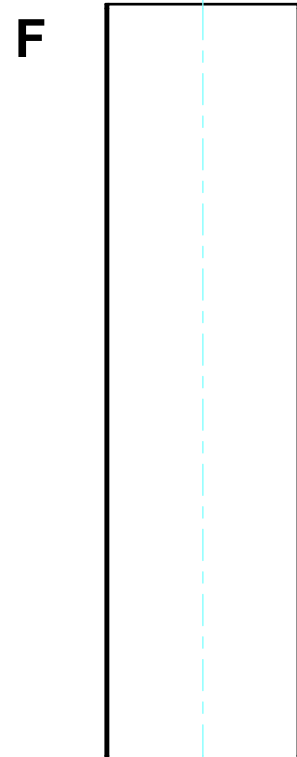
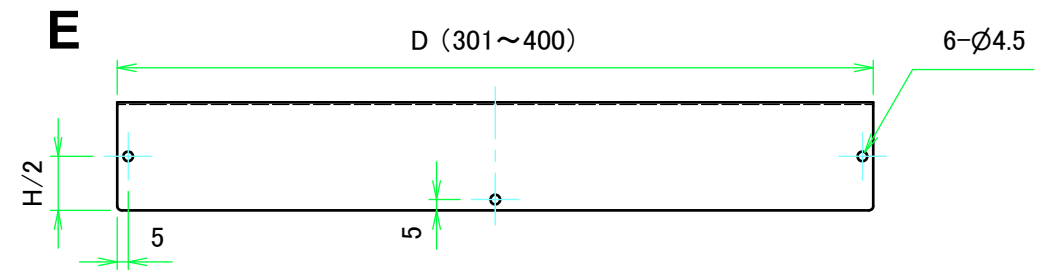
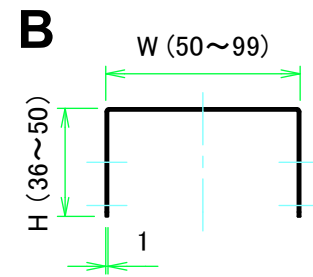
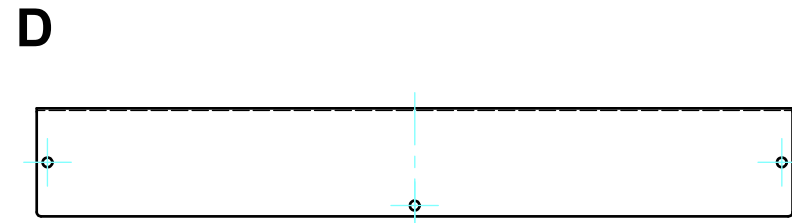
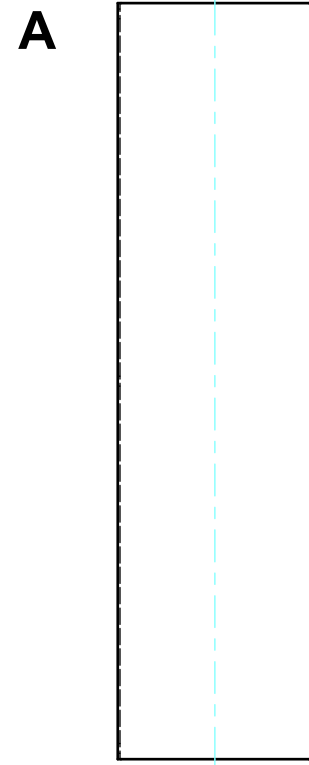
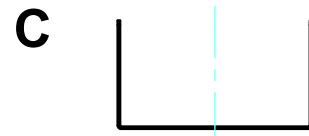

株式会社タカチ電機工業 TAKACHI ELECTRONICS ENCLOSURE CO., LTD.			品名/Title ステンレスフリーサイズケース CUSTOM DIMENSIONS CASE	尺度/Scale 1:3.5
承認/Approved	検図/Checked	製図/Created	型番/Product number MBS□-□-□ B10 (D ≥ 301)	
中根	大江	横田	作成日/Date 2019/06/24	2 / 3

シャーシ / Base

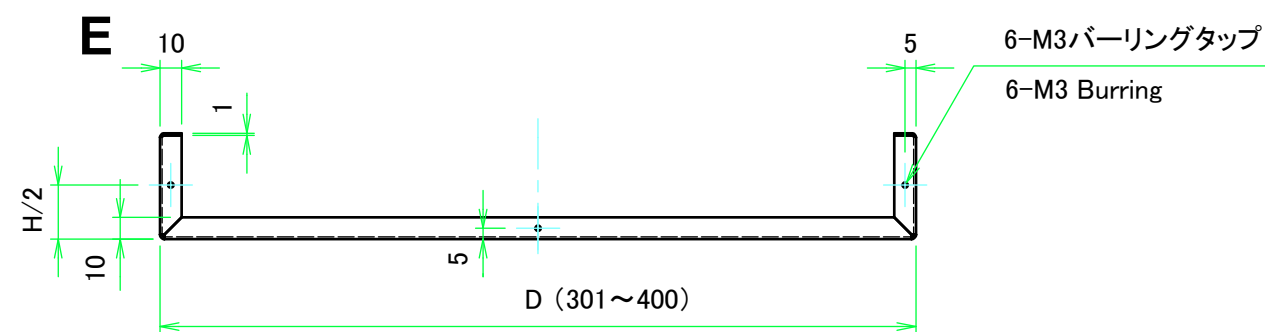
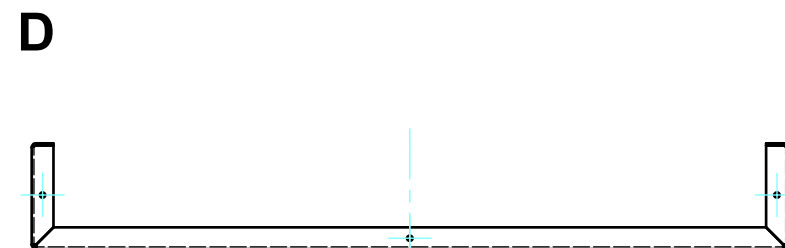
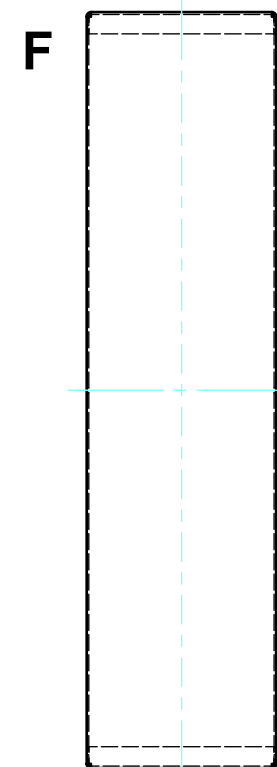
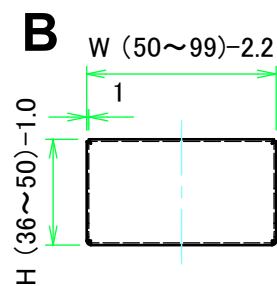
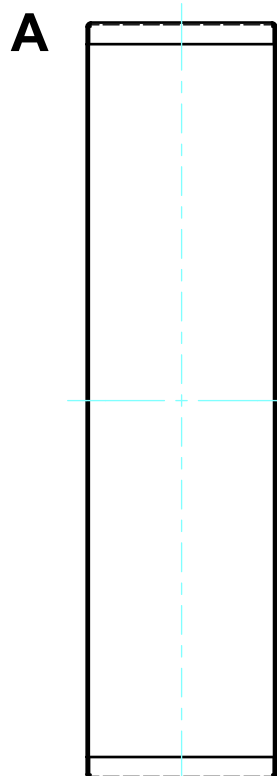
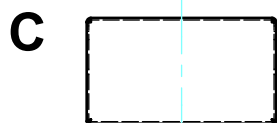

株式会社タカチ電機工業 TAKACHI ELECTRONICS ENCLOSURE CO., LTD.		品名/Title ステンレスフリーサイズケース CUSTOM DIMENSIONS CASE	尺度/Scale 1:3.5
承認/Approved	検図/Checked	製図/Created	
中根	大江	横田	作成日/Date 2019/06/24
			3 / 3